

# SWEFOG

## XEON II intellahazer



## Owner's manual

English

Rev: 0 April -2010

40 221-230 Xeon II intellahazer 230V 50 Hz

40 221-115 Xeon II intellahazer 115V 60 Hz



**IMPORTANT!**

Read all cautions and warnings prior to assembly, mounting and operating this equipment.

**IMPORTANT !**

Prière de lire toutes les précautions et les avertissements avant l'assemblage, le montage et de faire fonctionner cet équipement.

**WICHTIG !**

Lesen Sie alle Warnungen sorgfältig bevor Sie das Gerät zusammenbauen, installieren und benutzen.

**¡IMPORTANTE!**

Por favor, lea todas las precauciones y las advertencias antes de ensamblar, montar y operar este equipo.

**IMPORTANTI!**

Leggere tutti gli avvertenti prima di montare e usare questo apparecchio.

Manufactured by:  
**SWEFOG TECHNOLOGY GROUP AB**  
Industrivägen 15  
SE-682 33 FILIPSTAD, Sweden

Tel: +46 590 122 50

e-mail: [info@swefog.com](mailto:info@swefog.com)  
internet: [www.swefog.com](http://www.swefog.com)

## **TABLE OF CONTENTS:**

<b>HOW TO USE THIS GUIDE</b>	<b>4</b>
<b>QUICK SETUP GUIDE</b>	<b>4</b>
<b>1. INTRODUCTION</b>	<b>5</b>
1.1 The Swefog Xeon II intellahazer	5
1.2 Haze capacity	5
1.3 Some technical information	6
1.4 Intelligent Soft Start	6
1.5 About smoke fluid	6
<b>2. UNPACKING</b>	<b>7</b>
<b>3. SAFETY PRECAUTIONS</b>	<b>7</b>
<b>4. CE-CONFORMITY</b>	<b>8</b>
<b>5. INSTALLATION &amp; PRECAUTIONS</b>	<b>9</b>
<b>6. WIRING &amp; CONNECTORS</b>	<b>10</b>
6.1 Mains connection	10
6.2 DMX connection	12
6.3 DIN Remote 0-10V analogue connector	12
<b>7. OPERATION</b>	<b>13</b>
7.1 Technology	13
7.2 Control panel & display	13
7.2.1 Fan speed	14
7.3 Operation mode	15
7.3.1 DMX mode	15
7.3.2 Manual mode	16
7.3.3 Timer mode	17
7.3.4 A.S.O.C. – Advanced Sequence Operating Control	17
7.3.5 Remote / 0-10V mode	19
7.3.6 Fluid sensor ON or OFF	19
7.3.7 Switch OFF	20
7.4 MMS – Mode Memo System	20
7.5 LFS – Low Fluid Sensing LFS II & smoke fluid change	20
7.6 Mechanical overheating protection	21
7.7 Ducting system	21
7.8 Flying installation	21
7.9 Error messages	22
<b>8. SERVICE, MAINTENANCE &amp; REPAIR</b>	<b>22</b>
8.1 Software	23
<b>9. TROUBLESHOOTING</b>	<b>23</b>
<b>10. SWEFOG WORLDWIDE WARRANTY</b>	<b>25</b>

## How to use this guide:

For your safety, it is important that you read this manual thoroughly before you operate the Xeon II intellahazer.

This manual describes how to unpack, set up and operate the machine. It also lists important safety precautions and contains a separate service & maintenance manual for technical support.

In this manual you will find the following symbols:



**CAUTION**

**CAUTION:** This symbol appears adjacent to caution messages. Not heeding these messages could result in minor personal injury and/or damage to equipment.



**WARNING**

**WARNING:** This symbol appears adjacent to warning messages. Not heeding these messages could result in serious personal injury!

The owner's manual contains important safety precautions and information on how to use your machine. Always read the owner's manual before using the machine!

This manual and updates can also be downloaded as PDF-files from the internet: [www.swefog.com](http://www.swefog.com)

## QUICK SETUP GUIDE:

1. Read chapter 3: "SAFETY PRECAUTIONS".
2. Place machine on a level surface.
3. Fill a SWEFOG MiniTainer fluid canister with Swefog haze fluid, screw the metal cap on and tighten. Place the tank in the machine and connect the fluid suction tube.
4. (For DMX control only): Connect DMX cables
5. Connect to a mains outlet with earth lead.
6. Select operation mode by pressing MODE button.
7. Machine is ready after heat up, approx. 7 minutes.

## 1. INTRODUCTION:

The XEON II intellahazer is a high output haze generator. Due to the very precise output control and the integrated fan, the machine can be used for many purposes.

- High output, up to 2,800m<sup>3</sup> haze per minute.
- Continuous operation at all levels.
- Precise output control, 1 – 100%, adjustable in 99 steps.
- Cast aluminium heat exchanger with stainless steel vaporizer coil.
- Able to handle all kinds of Swefog water based haze & smoke fluids.
- High output radial fan turbine.
- Industrial air pump.
- Full R.I.S.C. microprocessor control. Software upgradeable.

We hope that you will be fully satisfied with the performance of your Swefog Xeon II intellahazer. To keep your machine functioning like new for its entire life, it is important to follow the instructions in this manual and to perform regular maintenance of the machine.

For the best results, use only original water based Swefog smoke or haze fluid (Neutral Pro series) in the machine. **Use of any other fluid will void the warranty.**

---

### 1.1 The Swefog Xeon II intellahazer:

The Xeon II intellahazer is a professional haze generator, with a high output capacity, powerful enough to fill large stages with haze. Without any need of settings or other adjustments, the machine can be used with all kinds of water based fluids in Swefog's "Neutral Pro" series. This makes the Xeon II versatile, as the user can choose the most suitable fluid for every venue; for normal use, light haze fluid (Neutral Pro XTR) is recommended, and a crystal-clear extremely light haze is created. If a high output is required (i.e. for filling outdoor stages or arenas), a medium density haze fluid (Neutral-Pro MD) or even a high density smoke fluid (Neutral Pro HD) can be used; this will maximize the output of the Xeon II intellahazer.

NOTE: The Xeon II intellahazer is an advanced haze generator, and is NOT compatible with other fluids than Swefog Neutral Pro. Other fluids will void the warranty and sooner or later damage internal components.

We recommend that you have some experience with smoke appliances to use the Xeon II, but you don't have to be an engineer to handle it. Just read this manual to understand your machine and get started!

---

### 1.2 Haze capacity

- In all modes, the Xeon II intellahazer can produce haze, fog or smoke (depending on fluid used) continuously, without interruption for re-heating.
- The output is never reduced, as the powerful heat exchanger is able to produce the selected volume of haze at all times, even at full (100%) output.

---

### 1.3 Some technical information

Very simplified, a haze machine contains a heat exchanger block, a fluid pump, a fan, an air pump and an electronic control module, ECM. The heater block contains a pipe system, an electric heater and metal, which works like a “battery” for storage of heat. The electronic module controls the temperature in the heater block and the pump speed. When haze is produced, the fluid pump starts to pump haze fluid mixed with air into the heater. Due to the very high temperature in the heater block, the fluid will vaporize to a white haze. When the fluid vaporizes, it consumes a lot of energy, which will cause the temperature in the heater block to sink. Unlike most competing hazers, the Xeon II contains an oversized heat exchanger, powerful enough to maintain its working temperature at all times, even at full output. The Xeon II never needs to reduce output (pump speed) or stop for re-heating.

Most haze generators work with the same basic design. The difference between a high performance generator and low-cost middle-of-the-road generators is the choice of internal components, electronic controls, user friendliness etc. Swefog Xeon II intellahazer is made with the use of industrial quality components, such as a stainless steel heat exchanger core, long-life heaters and non-compromise electronics. Most custom-made components are precision-built in Sweden; other standard components are mostly of west European origin. The end result is a high performance haze processor with detail quality which sets Swefog as an industry benchmark.

---

### 1.4 Intelligent Soft Start:

To maximize performance and safety, your Xeon II intellahazer is equipped with an advanced silent soft start system. Silent soft start is used to reduce “spitting” of unvaporized fluid during the initial burst of haze generation. The silent soft start electronics gradually powers the pump.

At output settings above 80%, the Xeon II will run pumps at 80% during the first 10 seconds. When 10 seconds have elapsed, the electronics will increase the pump speed to the selected output level. At selected outputs below 80%, the pump will always start at selected output, without soft start.

Please note: If the temperature is too low to generate haze, the pump will not start (READY indicator is off). This is a fully automatic system, controlled by the processor, and cannot (and should not) be disabled or modified by the user.

---

### 1.5 About smoke fluid

Most water based smoke or haze fluids contain glycols. The glycols in the mixture create the white particles that we recognize as smoke or haze. Three things are very important to remember about fluids and smoke machines:

- The water must be de-ionized. If the water contains minerals like calcium, salt etc; the pipes of the heat exchanger will first be coated causing poor output, and eventually they will clog completely, and your machine will be damaged. The pipes cannot be cleaned.
- The glycol used in the mixture has to be very clean. If not, it may clog the heat exchanger, and most important of all, if the glycol is not 100% pure, it may be hazardous to health, as it will contain a few fractions of unknown substances that may be dangerous to inhale when heated.

There are also many low-cost fluids available, manufactured from water and chemicals with unknown purity. The Xeon II intellahazer will probably work with most of them for a limited period of time, but as always: You get what you pay for.

Swefog smoke and haze fluids are based on pure, de-ionized Swedish water which is demineralized in an industrial laboratory, and absolutely free from minerals. It contains selected glycols of pharmaceutical (medical) quality only – the finest and most pure glycol available. The fluid is mixed and bottled in our factory, which guarantees full production quality control, and a clean fluid of the highest quality.

We strongly recommend that you use original fluids because the Xeon II intellahazer is a fine instrument and should be used with the original Swefog fluids it was developed for. Other fluids may be designed for a different vaporizing (heater) temperature or contain other chemicals and/or a different mix between water and glycols. Fluids from other manufacturers may work fine with their own fog machines, but if used in a Swefog fog / haze generator may cause problems with wet or toxic smoke. A clogged heater block can be replaced. Personal injuries may be permanent. Always remember, you are responsible for the safety of the smoke appliance. The manufacturer cannot be held responsible if the wrong type of fluid has been used.

Using Swefog original fluids, you will be 100% sure the smoke produced by your machine is non-toxic and safe, for both you and your machine.

## 2. UNPACKING:

The Xeon II intellahazer package contains one carton:

- One machine.
- One metal cap with integrated tube fitting and air inlet valve. The cap fits all Swefog neutral-Pro fluid canisters (5L).
- One manual

Save the cartons and packing material for future use. If the machine needs to be transported, ship placed on a small pallet preferably in the original box, and use straps to fix it to the pallet.

## 3. SAFETY PRECAUTIONS:



### WARNING

- **Smoke residues and fluid spillage may be dangerous. A slippery surface can cause serious personal injury! ALWAYS check surfaces before, during and after the use of the machine.**
- **Do NOT install this machine directly above an audience.**
- **Do NOT point the discharge directly towards an audience.**
- **Make sure the area in which this product is to be used is well ventilated.**
- **Do NOT operate near flammable materials or fire.**
- **Do NOT place hands or face near heat exchanger or output during operation. NOTE: There might be puffs of smoke from the output pipe when machine is not operating.**
- **Do NOT expose to rain or moisture.**
- **Connect to mains outlet with earth. Use a cable with earth. Check for correct voltage and/or mains frequency (see machine label). NEVER use the machine with wrong mains voltage or frequency.**

- **NOTE:** The condensation of the smoke makes floors, stairs and other surfaces slippery. Do **NOT** point the discharge towards cool or hard surfaces like wood, plastics, glass or metal. If the machine is frequently used, or used for a long time, check surfaces frequently.



**CAUTION**

- Use Swefog water based fluids only. Other fluids may damage the machine, cause residues inside and outside the machine, or cause toxic or odorous smoke. **USE OF ANY OTHER FLUID WILL VOID THE WARRANTY.**
- The fluid contains glycol. If it condensates, glycol may cause some types of paint to get wet. It may also affect other materials or surfaces. It may cause unprotected metal surfaces to corrode. Do not point the discharge directly to a painted or sensitive surface.
- **NEVER** mix or dilute the fluid.
- **NEVER** heat the fluid. Use room-temperature fluid only.
- Use responsible concentrations of fog to create atmospheric effects.
- **NOT** for residential use.
- **Operate in room temperature only.**
- **NEVER** cover vents or air inlets on the machine housing.
- Service internal parts **ONLY** if you have the know-how and experience to perform the service correctly. If not, please contact a Swefog service centre or the manufacturer. **NOTE:** Incorrect service works and/or the use of non-original spare parts will void the warranty.
- **NEVER** change parts or details inside, use original spare parts only!
- **NOTE:** If there is – for any reason – a fluid leakage or spillage, wipe off fluid spillage. **DO NOT** use the machine until it is mended.
- **NOTE:** The smoke may cause residues on mirrors, lenses and similar components. Keep away from equipment with fan ventilation.
- **Must be handled by personnel with adequate experience with smoke appliances.**
- **Operating the machine with an empty fluid tank will damage the pumps. Normally, the automatic pump shutdown system will disable the pumps when the fluid is almost empty (approx. 0, 05 L left).**

#### **4. CE-CONFORMITY (230V models only):**

We, Swefog, declare that the appliance described in this manual conforms to the EEC machine directive. Complete documents may be required from Swefog.





## 5. INSTALLATION & PRECAUTIONS:

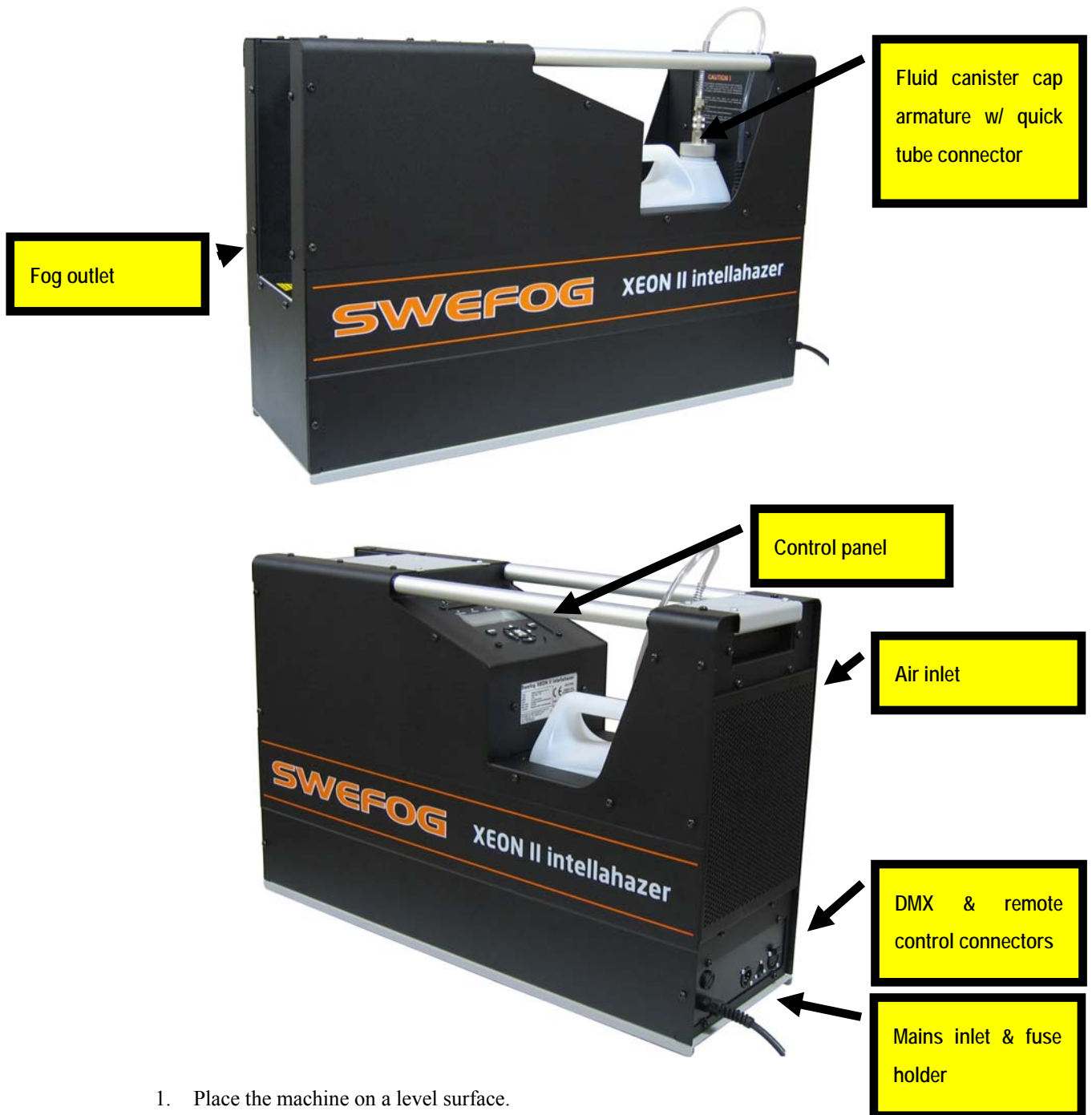

1. Place the machine on a level surface.
2. Use a Swefog neutral-Pro water based fluid. Open cap and replace with the included metal cap armature. Tighten the cap. Make sure the connection is airtight.
3. Place the canister in the canister space.
4. Connect the fluid tube to the canister.
5. NEVER fill fluid or replace canister while machine is operating. It is recommended to replace (not refill) the canister at fluid empty.
6. If the machine is to be used with DMX: Connect a 5-pin DMX cable to the male (=input) XLR connector. See below for further instructions.



**WARNING**

**RISK OF FIRE OR EXPLOSION!** NEVER use any kind of flammable liquid in the machine.

**OUTPUT NOZZLE BECOMES EXTREMELY HOT!** Keep hands off!

## 6. WIRING & CONNECTORS:

### 6.1 Mains connection:

Depending on which region the machine is made for, the mains connection connector and / or cable can be different.

**Standard equipment: Neutrik PowerCon connector.**

The standard mains connector for Xeon II is a Neutric PowerCon, approved for both 115V 60Hz (USA / Canada) and 230V 50Hz (Europe).

Xeon II is equipped with a MALE 20 Amp. power inlet connector type NAC3MPA.

Connect a mains cable (not supplied) equipped with a FEMALE connector, type NAC3FCA.

**NOTE: NEVER disconnect the PowerCon plug during load. Always switch machine off, unplug the mains plug first, then unplug / remove the PowerCon connected to the machine.**

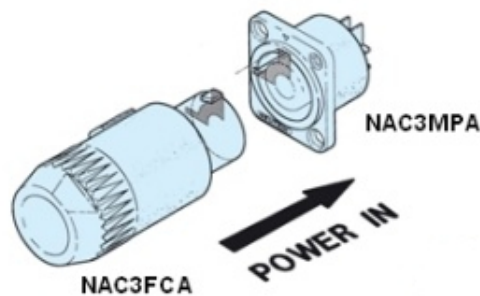

**Models equipped with a mains cable:**

**Some models may be equipped with a permanent installed mains cable with connector on. Depending on which mains voltage / frequency & region the machine is made for, the cable will be equipped with some of the following plug types:**

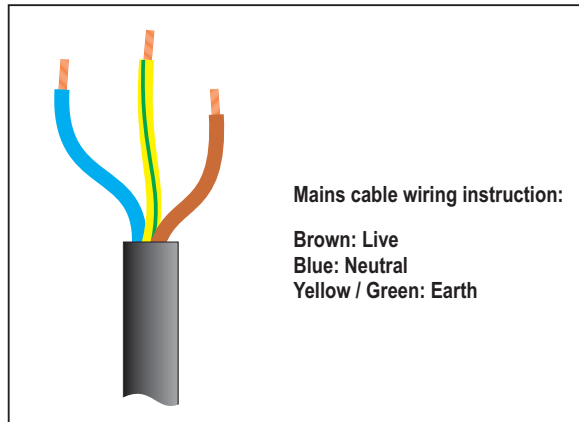

**WARNING**

### **RISK OF ELECTRIC SHOCK!**

**Refer to qualified personnel if the mains cable must be modified or replaced. NEVER use a damaged cable.**

---

**230V (European models):** Mains cable is fitted with a European standard Schuko plug with earth. If the plug is replaced, connect the wires as shown above. Use a mains plug approved for min. 10 Amps.



---

**115V (U.S. / Canadian models):** Mains cable is fitted with a U.S. standard type B mains plug with round earth pin. If the plug is replaced, connect the wires as shown above. Use a mains plug approved for min. 16 Amps.



## 6.2 DMX Connection:

### Chassis connectors

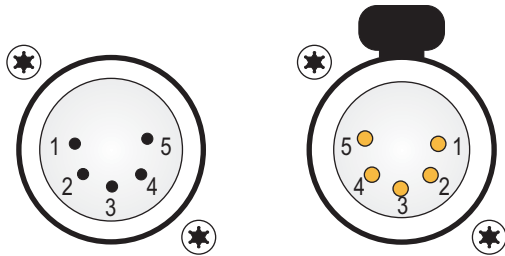

Male

Female

**Onboard XLR connectors:**  
 MALE: Data IN for receiving data.  
 FEMALE: Data OUT for transmitting data.

### Cable connectors

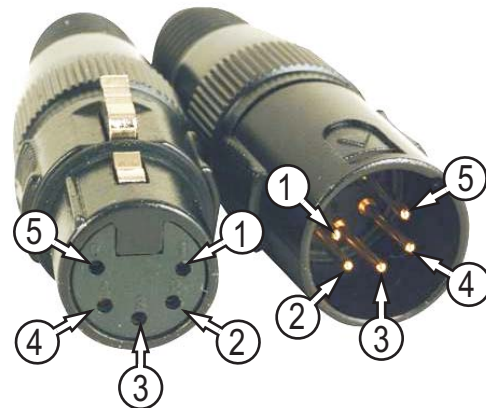

Female

Male

Use a 5-pin **female** XLR for DMX **input**.  
 Pin 1 = 0V (earth)  
 Pin 2 = signal - (negative)  
 Pin 3 = signal + (positive)

## 6.3 DIN Remote / 0-10V analogue connector:

DIN 41 524 pinout:

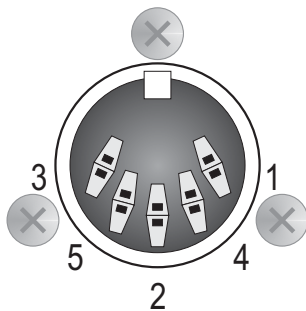

Chassis connector

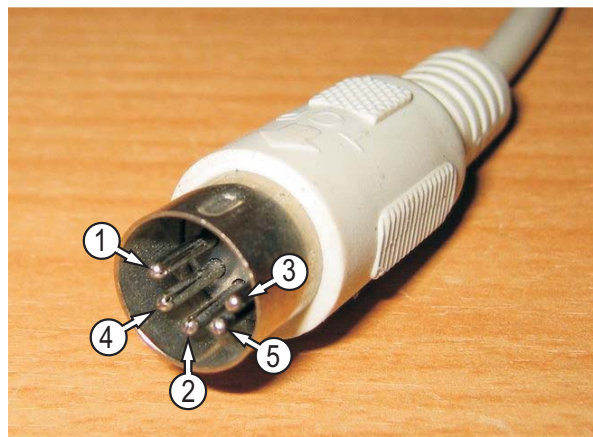

Cable connector

*Pinout: 1: Not used 2: Ground 3: Fan speed 4: Haze output 5: +12V output for use with Swefog remote controls ONLY. NOT for use with a light desk, other remote controls or any other purpose. Do NOT link or short circuit any pins, it may damage the electronics. If an external voltage source is connected for control (i.e. older types of light desks 0-10V), NEVER exceed 12V DC between earth and pin 3/4. See chapter 6:4, "Operation remote / 0-10V mode" for further information.*

## 7. OPERATION:

### 7.1 Technology:

The Xeon II intellahazer is a high performance haze generator system. All internal components are controlled by the microprocessor for safe operation. At start up from cold, the machine will perform the operations below before it is ready to generate haze. Once ready, it can produce haze as long as there is power and fluid:

NOTE: This machine uses the mains frequency sine wave (50Hz for 230V models, 60Hz for 115V models) for controlling electro-mechanical components inside, and timer functions. Interfering with the mains frequency may cause problems and malfunctions.

- Heating cycle: The machine starts to warm up the heat exchanger.
- At a certain temperature, the fan starts to idle at its lowest speed, 10%. The fan always runs when this machine is on and ready.
- At another certain temperature, the air pump starts (may cause a few smoke puffs when remaining fluid from last operation is forced through the heat exchanger)
- When it is ready to produce fog / haze, the green “ready” indicator is on.

Never run the machine with its cover removed. Xeon II uses several internal mechanical parts that rotates, are hot, electrical and starts automatically.

### 7.2 Control panel & display:

All settings & programming are made with the use of the control panel and the alphanumerical display.



**SWITCH ON:** Plug the Xeon II intellahazer into a power socket with the appropriate voltage.

NOTE: The machine consumes 1,800 Watts = 8 Amps at 230V & 15 Amps at 120V.

- Auto-ON: If the machine has been disconnected from mains, it will automatically switch ON when the plug is connected to a mains socket. The GREEN “standby” indicator is turned on.
- From Standby mode (RED “standby” indicator is turned on): Press and hold the “OK” switch until the “standby” indicator turns GREEN.

The Xeon II intellahazer will require approximately 7 minutes to heat to minimum

operational temperature, and approximately 9 minutes to heat to its highest temperature. At certain temperatures, the fan and air pump will start automatically.

**STANDBY INDICATOR:**

- No indication: The machine is disconnected from mains.
- RED: Standby.
- GREEN: Power ON.

**READY INDICATOR:**

- Until the GREEN “ready” indicator starts to flash, the pumps are unable to run.
- A flashing indicator indicates that the machine is able to produce haze, but the machine is still heating and is not yet at its full capacity.
- The indicator is turned on at highest temperature. This indicates maximum haze capacity.
- The indicator will start to flash during operation. This is normal, and indicates the machine is re-heating.

**TIMER INDICATOR:**

- YELLOW: Timer / A.S.O.C. is in operation.



**WARNING**

**At timer, A.S.O.C, DMX & 0-10V modes, machine may start and stop automatically!**

---

### **7.2.1 Fan speed (applies to all operation modes below):**

To achieve quiet operation and economical use, the Xeon II fan always idles at lowest speed (10%) when no haze is generated (smoke OFF). At smoke ON, the fan runs at selected speed. The speed can be selected in two ways:

- TRUE SPEED: At fan speed levels from 11% and up, the fan runs with the speed selected. The fan output level is indicated in the display.
- AUTO: Fan speed is proportional to haze output, i.e. low haze output = low fan speed, high output = high fan speed. AUTO mode is automatically selected at fan output levels from 10% and below.

## 7.3 Operation mode:

- Press MODE switch to select how to operate the machine: DMX / Manual / Timer / A.S.O.C. / Remote 0-10V/ Fluid sensor On or OFF / Switch off.

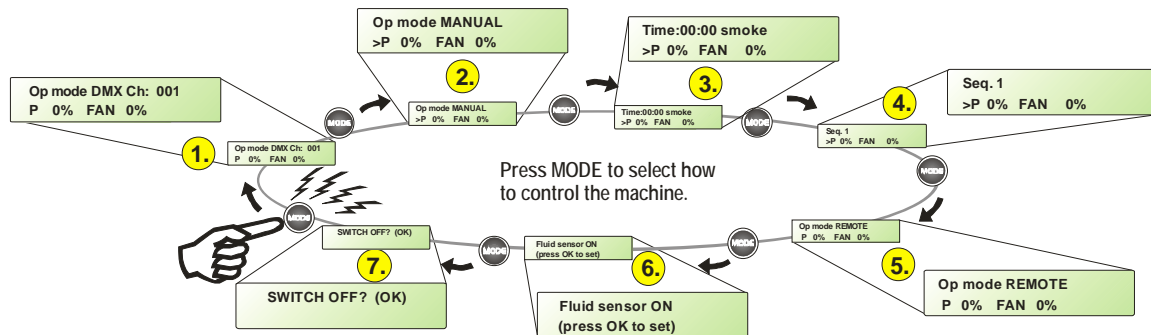

### 7.3.1 DMX mode:

Select DMX mode to control the machine from a DMX light desk.

#### 1. INTRODUCTION:

The display indicates: Operation mode (DMX), start channel, pump and fan output.

Op mode DMX Ch: 001  
P: 0%      FAN: AUTO

The machine uses maximum 2 channels:

Channel 1 = Output,

Channel 2 = Fan speed.

The most recently stored address will be stored in the processor's memory when the machine is switched off and/or mains voltage is disconnected. This address will be default next time the machine is switched on. In an application where the machine is used with the same address every time (e.g. on tour or in permanent installations), set of address is not necessary, as the machine always start up with the same address automatically.

If, for any reason, a different address is to be used temporarily: Set the temporary address (indicated in display window), but do not press "OK". The machine will respond to the temporary address until mains power is switched off. Next time it is switched on, the usual, favourite address will be set as default.

#### 2. ADDRESS PROGRAMMING:

- Press MENU to set a start address. Use the ▲ / ▼ buttons to select an address between 1 and 511. Press OK to store the address.

Set start address  
Ch: 001

- Press MENU for exit.

- The fog output is proportional to the DMX level:

Output %	DMX level	Output %	DMX level	Output %	DMX level
1	4	35	90	70	179
5	14	40	102	75	191
10	26	45	115	80	204
15	39	50	129	85	217
20	51	55	140	90	230
25	64	60	153	95	242
30	77	65	166	100	255

### 3. DAISY-CHAIN MULTIPLE FIXTURES:

Use a standard DMX cable, with one male and one female 5-pin connector. Use the male plug to connect to the DMX out (female) connector on the machine. Plug the other end (female connector) of this cable to the next unit in the series. Repeat this step with each successive unit in the chain (connect unit 2 to 3, unit 3 to 4 etc), until all units are connected.

**Daisy-chain rule:** You need one DMX cable for each unit you want to connect in the daisy-chain.

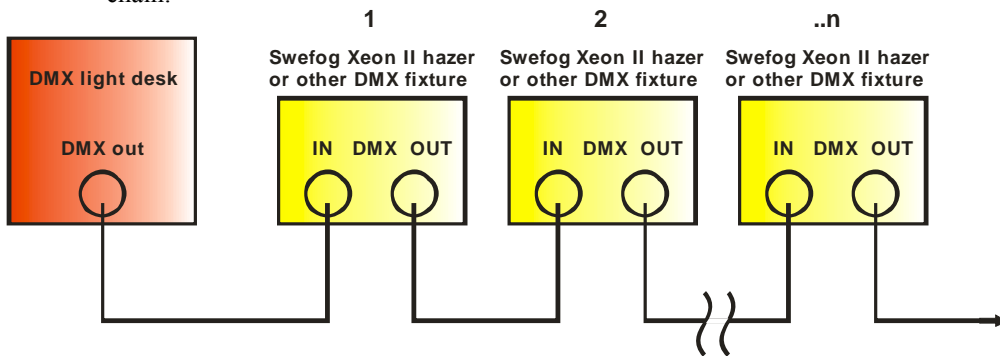

### 7.3.2. Manual mode (stand-alone):

Select manual mode if you wish to operate the machine from its keypad only.

```
Op mode MANUAL
>P 98% FAN 34%
```

1. Set fog output level (P) and fan speed (Fan): Use the ▲/▼ buttons to set an output level from 0 to 100%. Press and hold for faster count. Use the ◀/▶ buttons to change between smoke output and fan speed. An arrow indicates whether the smoke output (>P) or the fan speed (>Fan) is set.
2. Press OK button to start the production of haze. The RED “smoke on” indicator is turned on.
3. Press OK button to stop haze production.



---

### 7.3.3. Timer mode:

Select timer mode to produce haze at fixed time intervals. The Xeon II intellahazer uses the microprocessor to control time intervals, which makes the timer very precise.

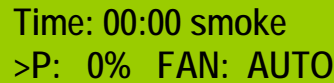

Time: 00:00 smoke  
>P: 0% FAN: AUTO

#### 1. INTRODUCTION:

The machine uses the microprocessor to control the timing process, which makes haze and delay times 100% precise.

#### 2. PROGRAMMING THE TIMER:

1. Press MENU to set “operate” and “delay time”. Use the ▲/▼ buttons to set time in seconds. Use the ◀/▶ buttons to change between operate and delay time. Press MENU to exit.



Set operate time  
00:00 (min:sec)

◀ / ▶

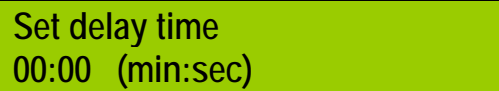

Set delay time  
00:00 (min:sec)

2. Set haze output level (P) and fan speed (Fan): Use the ▲/▼ buttons to set output level from 0-100%. Press and hold for faster count. Use the ◀/▶ buttons to change between haze output and fan speed. An arrow indicates whether the haze output (>P) or the fan speed (Fan) is set.

#### 3. ACTIVATING THE TIMER:

1. Press **OK** button to start the timer. The YELLOW “Timer” indicator is turned on. The display indicates remaining time (operate/delay). The RED “haze on” indicator is turned on when machine is operating. The indicator is off at delay status.

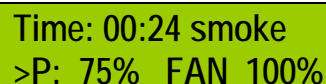

Time: 00:24 smoke  
>P: 75% FAN 100%

Press **OK** to stop the timer. The Yellow “Timer” indicator is off.

---

### 7.3.4. A.S.O.C. – Advanced Sequence Operation Control:

The A.S.O.C system allows the user to programme an individual profile, featuring run time, delay time, haze & fan output. The profile is programmed in 8 separate sequences (seq. 1-8), plus an initial delay sequence (seq. 0).

All settings for each sequence are programmed separately.

This function is suitable for any event where a specific run cycle is useful, without the need of externally programmed control sources like a light desk.

All settings are programmed – and stored – in Xeon’s processor memory. All sequences are kept in the memory even at power off. This saves time if the A,S,O.C. control mode is used often (i.e. on tour).

- A.S.O.C. is started and stopped with OK / Haze ON button.
- An initial delay can be programmed as a pre-runtime (Sequence 0).
- 8 sequences can be programmed (Sequence 1-8).
- Select **SINGLE RUN** (sequence 1-8 are run through one time only), or **REPEAT** (sequence 1-8 are repeated continuously).
- Sequence 0 is an initial delay used as a pre-run time setting. This sequence is never repeated. It can be used as a count-down timer for starting the programmed profile.
- Sequences with time set to 00:00 will be skipped automatically. Example: If only 3 sequences are needed to make a complete profile, make sure the unused sequences are set to time 00.00 and they will not be a part of the sequence.

The following 3 settings are programmed repeatedly for each sequence 1-8:

- Sequence run time (max time 59 min, 59 sec).
- Haze output (1-100%)
- Fan speed (AUTO, 11-100%).

**Programming an A.S.O.C. profile:**

- Use ▲/▼ buttons for up / down settings.
- Use ◀/▶ buttons for moving cursor back / forward.
- During setting, the cursor is always indicated with a “>” symbol in the display.
- To set an operating sequence; set run time, haze output & fan speed.
- To set a pause (delay) time, set time to desired pause time and ensure output is set to 0% (fan will automatically run at lowest speed when output is 0%).

To make settings, follow the steps below:

1. Go to A.S.O.C. mode: Press MODE button until the menu shown below appears:

Set:0 00:00 (min:sec)  
Initial delay (OK)

2. Press MENU.
3. Set initial delay (pre-run) time with ▲/▼ buttons. NOTE: If no initial delay is wanted, set time to 00:00.
4. Press ▶ button for next sequence. Display show settings of sequence 1:

Set:1>00:00 (min:sec)  
P 0% FAN AUTO

5. Make all necessary settings for Time, Output, Fan speed.
6. Press ▶ button for next sequence. Display shows settings of sequence 2:

Set:2>00:00 (min:sec)  
P 0% FAN AUTO

7. Make settings using the same method for all sequences 2 – 8. To skip a sequence, set time, output & fan speed to 0, and go to next sequence.
8. When sequence 8 is programmed, press ▶ button for repeat menu:

Set sequence run  
single run

9. Use ▲/▼ buttons to set single run or repeat.
  - **SINGLE RUN**: Sequence 0 – 8 will be run through once.
  - **REPEAT**: Initial delay (sequence 0) is run once. Then sequences 1 - 8 will run continuously ,

- until operation is stopped manually by pressing Smoke ON button.
10. When all settings are done, press MENU to go back to A.S.O.C. start menu.
  11. Press OK to start. All settings are now stored in the processor's memory, and are not erased at power-off.
  12. To make changes, repeat steps 2-11 above.

---

### 7.3.5. Remote / 0-10V mode:

Select this mode to control the machine with a Swefog analogue remote control (optional) or a 0-10V light desk.

A green rectangular display box with black text. The top line reads "Op mode REMOTE" and the bottom line reads "P 0% FAN 0%".

Connect the remote control or a cable from a light desk to the 5-pin DIN connector. The haze output and the fan speed are proportional to the amount of voltage supplied.

Swefog analogue remote control:

1. Select haze output with the "fog output" button.
2. Select fan speed with the "fan speed" button.
3. To produce fog, press the "smoke on" switch.

NOTE: When the analogue remote control is used, all values are approximate. The display on the machine indicates the current smoke output. Using an analogue remote controller means less precision and approximate output values.

---

### 7.3.6. Fluid sensor ON or OFF:

A green rectangular display box with black text. The top line reads "Fluid sensor ON" and the bottom line reads "(press OK to set)".

Xeon II uses a fluid empty sensor to protect the pump and notify user the fluid is empty. This sensor is a photo cell that senses fluid or no fluid (air) in the suction tube that goes from fluid canister to the pump. If the machine is generating fog (smoke ON) and sensor measures no fluid in the tube during 2 minutes, the machine will interrupt fog and "Fluid empty" message appears in the display. Manual reset by pressing OK button.

In some cases it may be necessary to disable the sensor, i.e. if there is a risk of air bubbles in the tube, and machine will be used at a very low output, and user don't want to risk an unwanted interrupt. To disable the sensor, use < and > buttons, display indicates Fluid sensor OFF. To store, press OK.

NOTE: Fluid sensor will be disabled until it is enabled in this menu. For normal use, it is recommended to activate the sensor to avoid damage of fluid pump.

Read more about fluid sensor LFS II under chapter 7.5 below.

---

### 7.3.7. Switch off:

Switch OFF? (OK)

Press **OK** for switch off.

NOTE: The machine will first empty the heat exchanger system during 60 seconds. **DO NOT** unplug the machine from mains during the switch-off countdown cycle! Time left to switch off is indicated in the display window:

Do NOT unplug mains  
Auto shutdown in 59s

Unplugging the machine before the 1-minute switch off cycle is completed means there may be fluid left in the internal piping system. This may cause a clogged heater (not covered by warranty). It can also cause unwanted smoke bursts next time machine is switched on. When the air pump starts, it will push out remaining fluid resulting in unexpected smoke puffs.

NOTE: Even if the switch-off cycle is completed, a few fluid drops may be release from the internal fluid pump during transport of the machine. When the air pump starts, it will force out all remaining fluid through the heat exchanger. If the machine has been moved or transported, one or a few smoke puffs may occur during the heat-up cycle, especially when the air pump is activated during heat-up.

The RED standby indicator indicates the machine is switched off and set into the standby mode. At standby mode, the main processor, heater, pumps and all other internal electrical parts are OFF. The machine uses a power save circuit which only senses the OK button for switching on, and the power consumption is less than 0,5W.

---

### 7.4 MMS - Mode Memo System:

At power on, the machine will automatically start with the same operation mode used last time. In DMX mode, it will also remember the most recent DMX address programmed. Read more, chapter 2, “DMX mode”.

It also stores all programmed data in the A.S.O.C. mode.

The MMS feature is a useful function for permanent installations, touring or any other application where the machine is always used with the same operation mode.

---

### 7.5 Low Fluid Sensing – LFS II & Smoke fluid change:

FLUID EMPTY  
(press OK to reset)

The Xeon II intellahazer is equipped with LFS II, an optical “photo-cell” type wireless low fluid level sensing system, which will prevent the pump from running dry damage.

The LFS II system detects air bubbles in the fluid supply tube. When the fluid canister is empty, the optical sensor detects the air in the fluid supply tube. The pumps are now allowed

to run for 120 seconds.

If air can still be detected in the tube, the pump is disabled to avoid dry run damage. Replace the fluid canister (or fill the old one with haze fluid), and press OK to reset the system.

Again, pumps are allowed to run dry for 120 seconds. As soon as fluid is detected by the optical sensor, the system is automatically reset to avoid unwanted interruptions due to a few single air bubbles in the tube. Run the machine until the tube is filled with fluid and no air bubbles can be seen.

NOTE: If unwanted interruptions occur despite a fluid refill, it may be caused by air bubbles. Run the machine for approximately 2-5 minutes at full output to clear out all air bubbles in the system. It will prevent unwanted interruptions and guarantee a smooth haze output. If for any reason, the sensor should be disabled, use the menu described under chapter 7.3.6 above.

When fluid is out:

- Replace or refill the empty fluid canister. Clean canister compartment and the fluid connectors.
- Ensure the fluid tube fitting is properly connected to the new canister, without risk of air leaks.
- Run the machine in “manual” mode at pump full speed (100%).
- While pump is operating, check the fluid suction tube. Run the machine for several minutes until no air bubbles can be seen in the tube, to ensure a “bubble-free” fluid tube.
- If pumps are automatically stopped during the fill-up process (Fluid empty message appears in display), press OK to reset. Pumps are now allowed to run for another 120-sec period. NOTE: The system is automatically reset when haze fluid is detected in the tube.
- Always ensure no air bubbles are left in the suction tube. At low output settings, air bubbles may cause problems with unwanted interruptions caused by the fluid empty sensor.

---

## 7.6 Mechanical overheating protection:

The Xeon II intellahazer uses two mechanical overheating protection switches: one for the air pump motor and one thermostat for the heater block. All will automatically reset after being activated.

---

## 7.7 Ducting system:



Xeon Intellahazer is NOT suitable for use with a ducting system. There should be no objects preventing the air blow and haze burst from the machine. Using ducting systems or other objects preventing a free air flow may cause haze coming into the machine. The haze can condensate, causing electrical problems.

---

## 7.8 Flying installation:



Xeon Intellahazer is NOT suitable for use as a flying installation. The machine is designed for a floor position, blowing the haze in an angle, 40° upwards.

If the machine is installed above floor level, ensure it is NOT installed close to or above an audience.

---

## **7.9 Error messages:**

If a problem is discovered by the processor, it will automatically shut down the machine, and display an error code. If an error code appears in the display, contact your Swefog dealer to solve the problem. The basic error messages are: C101, C102, and C103. All these error codes indicate a problem with the temperature sensing system.

If the message “Serve clogged heater” appears, the internal system has indicated the heat exchanger is clogged. As a protection, the smoke output is disabled.

If the machine has not been transported in upright position, fluid drops may come into the air tubes, resulting in false alarm. Always reset the error message and test the machine. If it operates normal and the haze output is good, the heater is not clogged.

---

## **8. SERVICE, MAINTENANCE & REPAIR:**

The Xeon II intellahazer is made with high quality, industrial standard components. If regular care and maintenance is performed, the machine will last for many years of use.

If you have good know-how and adequate experience with smoke machines, you may perform cleaning and basic troubleshooting. If not, refer servicing to qualified technical personnel, or contact a preferred Swefog dealer. NEVER try to adjust or modify electrical or mechanical parts. Preferred dealers will provide qualified service technicians, and will be able to perform most service works.

This manual contains basic troubleshooting only. For serious problems with your machine, contact your Swefog dealer.

- Check air filter behind frame at machines rear. Replace air inlet filter if necessary, can be purchased from your Swefog dealer.
- Check & replace compressor’s air filter every 6 months or after 200 hours of use. If the machine is often used in dusty environments, replace filter more often. To replace the compressor air filter, the machine must be opened for service. Refer to a qualified service shop or your Swefog dealer.

---

## 8.1 Software:

The Xeon II intellahazer uses a powerful microprocessor to control all functions. The microprocessor uses software. If you suspect a problem with the processor, or malfunction on electronics, always check the software version. Every time the machine is switched ON, the model name and software version is displayed for 2 seconds in the display window:

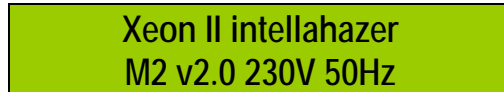

Xeon II intellahazer  
M2 v2.0 230V 50Hz

Line 1: Name & model indicator

Line 2: Software version & mains voltage / frequency configuration.

The software version number cannot be confirmed by reading the machine label or serial number. Due to updates, the software versions may be changed several times during the lifetime of your machine. Always look for the correct software version shown in the display window.

## 9. TROUBLESHOOTING:



**CAUTION**



**WARNING**

**RISK OF ELECTRIC SHOCK! DISCONNECT FROM MAINS BEFORE OPENING THE MACHINE!  
SOME INTERNAL PARTS MAY BE EXTREMELY HOT!**

**NOTE:** Swefog Technology Group AB continuously releases service bulletins, when necessary. The bulletins describe detected problems, and how to solve them. To prevent competitors from copying technical design and information, the service bulletins are not distributed to the public. The service information is released to authorized distributors only. However, if you need help solving a problem yourself, always contact Swefog. Always provide information on model, serial number and a detailed description of the problem.

- **MACHINE DOES NOT START UP WHEN CONNECTED TO A POWER SOCKET:**

**Q:** Does the “standby” indicator show red?

**YES:** Press and HOLD the “OK” button until the machine is on, and the display lights up after approximately 5 sec.

**NO:** Check the power socket and/or its fusing. The machine consumes 1,800 Watts (8 Amps @ 230V, 15 amps @ 120V).

- **THE MACHINE DOES NOT RESPOND TO DMX:**

First, check for proper DMX cable wiring and that the correct DMX address is set. If the machine still does not work, restart the machine:

1. Switch the machine off: Press the MODE button until “Switch off?” appears. Press OK. Unplug the machine from mains for approx. 30 seconds.

2. Re-plug the machine, if it does not start up automatically: Press and HOLD the “OK” button until the machine is on, and the display lights up.

3. Check if the machine responds to the DMX signal

- **ERROR MESSAGES:**

If there is an internal error on components or sensors, the machine will not be able to operate, for safety reasons. The basic error messages are: C101, C102, and C103. All these error codes indicate a problem with the temperature sensing system.

Please note, there might be other error messages displayed, depending on updated software and technical improvements. Check with your dealer, or at [www.swefog.com](http://www.swefog.com) for updated manuals and service bulletins. Never repair or modify the machine yourself. Refer to qualified personnel.

- **ANY OTHER PROBLEM:**

If the remedies above fail to solve the problem, or if any other problem exists, contact a qualified service technician at your dealer or distributor.



## 10. SWEFOG WORLDWIDE WARRANTY:

### **Unpacking and Saving the Shipping Materials**

The customer would be well advised not to discard the Swefog shipping carton and packing materials. These items are specifically designed to protect this product during transport.

If you ever need to return a product for repair or maintenance, you should return it in its original shipping carton and packing materials, or materials of the same standard. To avoid fluid leakage during shipping, place the carton on a small pallet and secure the carton to the pallet with the use of straps. Even with an empty tank, fluid leakage may occur due to fluid remains in the tank and haze filter. If a returned machine requires extra cleaning due to fluid leakage during transport, the owner will be charged for the extra labour required and/or replacement of damaged parts due to fluid leakage.

To protect the machine during transport, always ensure the machine is transported upright at all times!

### **Inspecting the Contents**

Carefully remove the contents of each shipping carton and inspect the machine for signs of freight damage. In case of any such damage, notify both the shipping agent and the sender immediately (may it be the sales agent or the manufacturer).

Any damage incurred in shipping is the responsibility of the carrier. In the case of hidden damage, a claim should be made as soon as damage is discovered. All packing material should be retained for inspection.

**NOTE:** Freight damage claims are invalid for fixtures or other spare parts shipped in non-factory shipping cartons and packing materials.

### **Limited Warranty**

Unless otherwise stated, Swefog products are covered by a one-year parts and labour limited warranty.

Guarantee will be invalid if the Swefog machines have been used with non-original fluids.

It is the owner's responsibility to furnish receipts or invoices for verification of purchase, date and dealer or distributor. If purchase date cannot be provided, date of manufacture will be used to determine warranty period.

### **Returning an item for repair covered by warranty**

**Before** any units are sent to Swefog for repair, a Return (RMA) Form has to be filled out. This RMA form can be obtained by contacting Swefog [info@swefog.com](mailto:info@swefog.com) or downloaded from our website [www.swefog.com](http://www.swefog.com). The manufacturer will then make the final determination as to whether or not the unit is covered by warranty. All shipping will be paid by the purchaser. Transport costs for the returned units are not covered by the warranty and will henceforth be at the cost of the sender.

### **Under no circumstances will freight collect shipments be accepted.**

Repair or replacement as provided for under this warranty is the exclusive right of the customer.

**Swefog Technology Group AB shall not be liable for any indirect, incidental or consequential damage, including lost profits, sustained or incurred in connection with any product or caused by product defects or partial or total failure of any product regardless of the form of action, whether in contract, tort (including negligence), strict liability, or otherwise and whether or not such damage was foreseen or unforeseen.**

**Warranty is void if the product is misused, damaged, or modified in any way.**

